

OW12

SUBWOOFER

Installation Instructions | Owners Manual

www.okurelectronics.com

Due to continuous improvement of the product, specifications are subject to change without notice



INTRODUCTION

Congratulations on your purchase of an OKUR state-of-the-art subwoofer. Your selection of an OKUR car audio product indicates a true appreciation of fine musical reproduction. Whether adding to an existing system or including your OKUR subwoofer in a new system, you are certain to notice immediate performance benefits.



PRODUCT COMMITMENT

OKUR's engineering professionals harnessed years of expertise, experience and passion, coupled with exhaustive testing and creative design to develop the optimal product and performance for your musical enjoyment. This is our commitment to you. It's what you deserve and have come to expect from OKUR. We appreciate the confidence and look forward to your positive experience.



KEEP YOUR SALES RECEIPT

Take this time to attach your sales receipt to the manual and put in a safe place. In case of any unforeseen reason this product may need warranty service, your receipt will be necessary to establish purchase date.



RECOMMENDATION

A power subwoofer's performance is only as good as its installation. Proper installation will maximize the system's overall performance. It is recommended that you have our product installed by an authorized OKUR retailer. However, if you decide to install it yourself, please carefully read through this manual and take your time to do a quality installation.



OPTIMAL PRODUCT CHOICE

To get the Maximum performance out of your stereo system, we recommend using 100% authentic OKUR electronics and DB LINK wiring and accessories. Matching OKUR amplifiers and Speakers with your state-of the art electronics purchase is critical to optimize your system's performance. Wiring is the lifeblood of a system, make sure your audio system has the adequate current and signal transfer it deserves and needs. DB Link has it all, from wiring rolls; Speaker, power, ground and remote to amplifier kits, RCAs, and Fuse holders, distribution blocks and battery connectors. Insist on getting the best, DB LINK. It's what you deserve to get the optimum performance from your audio System.

IMPORTANT

Before making any connections, disconnect the car's battery until the installation is completed to avoid possible damage to the electrical system.

WARNING!

Exposure to high power sound system can cause hearing loss or damage. Listening to your system at loud levels while driving will impair your ability to hear traffic sounds and emergency vehicles. Use common sense when listening to your system.

Serial # _____ Model # _____

PRODUCT FEATURES

- Compressed Paper Cone
- Double-stitched foam surround
- Heavy Gauge Stamped Steel Basket
- Proprietary Full Round PVC Gasket
- Heavy Gauge Spring Terminals
- Protective Magnet Cover

OW12	
Structure:	12" (30.48cm) Woofer
Max Power:	1500 Watts
Nominal Power:	350 Watts
Impedance:	2" (50.8mm) 4Ω Dual Voice Coil

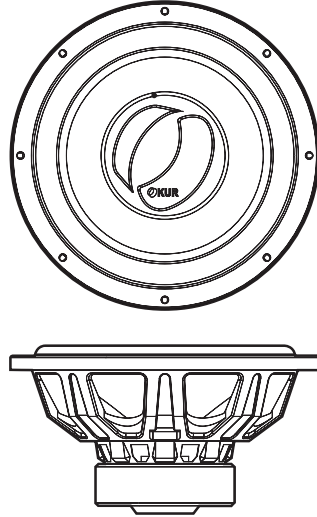

PRODUCT SPECIFICATIONS

OW12	
FS:	35.55 Hz
Re:	3.6 Ω + 3.6 Ω
Qms:	4.522
Qes:	0.769
Qts:	0.657
VAS:	43.851
Cms:	118.397 um/N
BL:	8.867 N/A
Mms:	169.219 gr
SPL:	81.6dB
Xmax:	14mm

PRODUCT DIMENSIONS

- A** Frame Diameter
- B** Mounting Depth
- C** Cutout Diameter

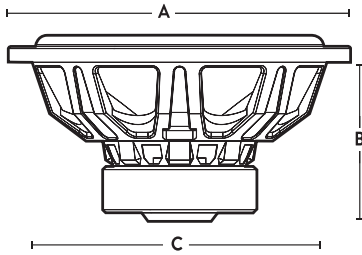

OW12	
A Frame Diameter:	12.77 in. (324.50 mm)
B Mounting Depth:	5.93 in. (150.80 mm)
C Cutout Diameter:	10.94 in. (278 mm)

RECOMMENDED ENCLOSURES

The purpose of the information below is to help you select the most appropriate type of enclosure for your application. We have selected the two most popular enclosure types and their performance benefits.

Sealed Enclosure: (Air-Suspension design): Characteristically simpler to make, sealed enclosures usually are better at controlling the woofer's excursion and performance at lower frequencies. The added control allows for higher power handling or use of a bigger amplifier. The secret is to maintain a perfect seal. Using Glues and sealants at all seams is recommended to prevent leaks and integrity of the enclosure. The size or volume of the enclosure will directly affect the performance of the woofer. Smaller enclosures generally provide the desired bump to the frequency response curb and Greater SPL. Larger enclosures will provide a lower but flatter response for deeper bass. In general, the benefit to the sealed enclosure versus a ported enclosure is a smaller foot print, simpler build with higher power handling, a more linear flat response, superior sound quality and extended low frequency output.

Ported Enclosure: (Bass-Reflex or Vented): A ported enclosure is simply a sealed enclosure with a port or vent added to the sealed design for the purpose of tuning the enclosure to higher output at the desired tuned frequency, typically 3db or higher. Another advantage of a ported enclosure is the reduction of cone motion for the speaker, thus distortion at higher power levels within the tuned frequency response of the port. A drawback is that building a ported enclosure is more complex than sealed. Having the wrong port or vent could result in poor sound, and the potential of damaging a woofer when played too loud or out of the tuning frequency. Thus we recommend not guessing, please follow the guidelines listed in this manual or go to a professional. In General, the benefit of a ported enclosure versus a sealed is higher volume output at the tuned frequency, stronger bass output with lower power input.

Construction: We recommend using $\frac{3}{4}$ " MDF (Medium Density Fiberboard) for the construction of an enclosure. It is critical for the side walls of the enclosure not to flex due to the pressure generated by the woofer, bracing might be required. The enclosure sides should be secured together with nails/screwed. We also recommend the use of glues and sealants to maintain the integrity of the enclosure and eliminate leaks.

RECOMMENDED ENCLOSURES

ENCLOSURES:		OW12
Woofer Cut-out:	10.94 in. (278 mm)	
Mounting Depth:	5.93 in. (150.80 mm)	
Sealed Box:	1.125cu ft (31.85 L)	
Vented Box:	1.59 cu ft (45.02 L)	
• Vent Area:	12.57 sq in (81.09cm ²)	
• Vent Length:	16 in. (40.64cm)	
• Tuning:	36Hz	
Dynamic Power :	1500 Watts	
Nominal Power :	350 Watts	

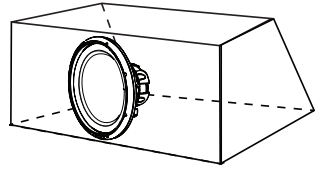

Sealed

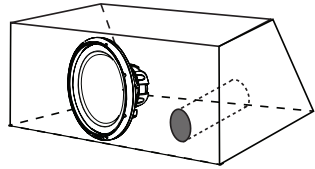

Vented

CALCULATING ENCLOSURES

It is recommended to build your enclosure from at least 3/4" thick MDF (medium density fiber board). Make sure the enclosure is sealed airtight.

▪ **Calculating External Volume**

To calculate box volume, measure the outside Width x Height x Depth of the enclosure. Example 12" x 14" x 9"=1512 ÷ 1728" Cubic feet.

Next you must convert cubic inches into cubic feet. To do this, you must divide the cubic inches total by 1728". Example 1512 ÷ 1728=.875 Cubic feet.

▪ **Calculating Internal Volume**

To calculate the internal (net) volume of the above box you must first multiply the thickness of the wood you are using by Two(2). Example 3/4" x 2= 1.5"

Next subtract 1.5 from each of the outside measurements of the box.

Width

$$12 - 1.5 = 10.5$$

Height

$$14 - 1.5 = 12.5$$

Depth

$$9 - 1.5 = 7.5$$

Multiple the new totals (H x W x D) Example: 10.5 x 12.5 x 7.5 = .5696

Next you must convert cubic inches into cubic feet. To do this, you must divide the cubic inch total by 1728". Example 984.375 ÷ 1728=.5696 cubic feet.

DVC WIRING CONFIGURATIONS

You can change the wiring configuration of your speakers (Series, Parallel and Series / Parallel) to match the impedance loads that maximizes the power output of you amplifier. Wiring the same woofer or multiple woofers in these three different wiring configurations will result in different impedance loads.

Series: Is the method of wiring of alternate positive with negative terminals (string method) (Illustration below).

Parallel: Is the method of wiring where you wire match 2 speaker terminals with positive to positive terminal and negative to negative. (Illustration below).

Series/Parallel: This configuration is a combination of both series and parallel. We recommend series for the terminal and parallel for the leads to amp. (Illustration below).

4Ω DVC WIRING CONFIGURATIONS

1 X 4Ω DVC SUBWOOFER

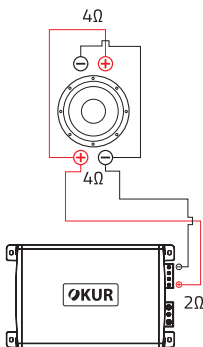

2 X 4Ω DVC SUBWOOFER

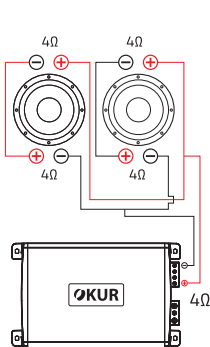

2 X 4Ω DVC SUBWOOFER

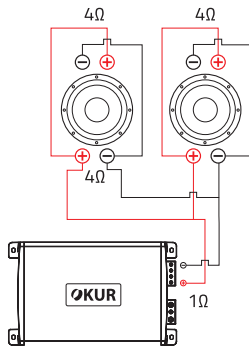

3 X 4Ω DVC SUBWOOFER

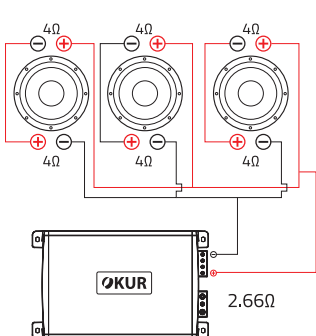

4 X 4Ω DVC SUBWOOFER

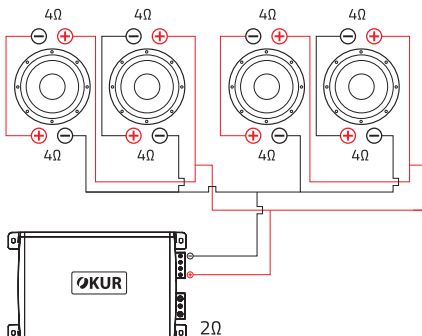



LIMITED WARRANTY

OKUR™ warrants any products purchased in the U.S.A. from an authorized OKUR™ dealer.

All products are warranted to be free from defects in material and workmanship under normal use and service for a period of one (1) year. This warranty applies to the original purchase only.

OKUR™ will either repair or replace (as its option) any unit that has been found to be defective and under warranty provided the defect occurs within the one (1) year warranty period.

This limited warranty does not extend to units have been subjected to misuse, abuse, neglect, or accident. In OKUR™'s judgment, products that show evidence of having been altered, modified, or serviced without OKUR™'s authorization, will be ineligible under this warranty.

To obtain warranty service please contact your retailer or visit our website at www.okurelectronics.com for more details.



DB Research L.L.P. ■ 302 Hanmore Industrial Parkway ■ Harlingen, TX 78550
Ph: (877) 787-0101 ■ Fax: (956) 421-4513 ■ tech support: support@dbdrive.net

Designed and Engineered in the U.S.A. 